



## Dear customer,

Please read these operating instructions carefully and pay particular attention to the safety notes indicated in the first pages. We recommend that you keep this instruction booklet for future reference and pass it on to any future owners.



The warning triangle and/or the key words (Warning!, Caution!) emphasize information that is particularly important for your safety or correct functioning of the appliance.



This symbol guides you, step by step, in the operation of the appliance.



The information marked with this symbol provides additional instructions and practical tips on the use of the appliance.



Tips and information about economical and ecological use of the machine are marked with the clover symbol.

If you require assistance or advice on your appliance, please contact our customer care department by letter or telephone:

Customer Care Department

AEG Domestic Appliances

55-77 High Street

Slough

Berkshire SL1 1DZ

Tel: 08705 350350\*

\* calls to this number may be recorded for training purposes.

## Important

Your machine is fitted with a balance control device, which ensures the machine is stable during the spin.

If the wash load appears not to have been spun sufficiently at the end of the wash cycle, because it is not evenly distributed in the drum, the balance control device may have operated. It will therefore be necessary to redistribute the wash load manually and select a spin programme. For more detailed information see the section headed "Something Not Working".

Printed on recycled paper.

People who think ecologically, act accordingly...

# Contents

<b>Safety instructions</b> .....	6-7
<b>Disposal</b> .....	8
<b>Tips for environmental protection</b> .....	8
<b>Main features of your washing machine</b> .....	9
<b>Description of the appliance</b> .....	10
Control panel.....	11
Programme selector dial.....	11
ON/OFF button.....	12
MAINS-ON light.....	12
START/PAUSE button.....	12
DELAY START button.....	12-13
Programme Option buttons.....	13
SPIN SPEED and NO SPIN.....	13
PREWASH.....	13
STAIN.....	13
QUICK WASH.....	14
RINSE HOLD.....	14
EXTRA RINSE.....	14
Display.....	15
Programme progress display.....	15
Cancelling/Altering a programme.....	16
Opening the door after the programme has started.....	16
Detergent dispenser drawer.....	17
<b>Before the first wash</b> .....	17
<b>Preparing the wash cycle</b> .....	18
Sorting out and preparing the laundry.....	18
Weight of laundry.....	19
Types of fabric and care labels.....	19-20
Detergents and additives.....	21-22
Which detergent?.....	21
And in which form?.....	22
Fabric conditioners.....	22

<b>How to wash</b> .....	23
Max. load .....	23
Load the laundry.....	23
Add detergent and additive.....	23
Switching the machine on.....	23
Selection of the desired wash programme.....	24
Selection of the SPIN SPEED or NO SPIN option .....	24
Selection of the STAIN, PREWASH or QUICK WASH option.....	24
Selection of the RINSE HOLD and/or EXTRA RINSE option .....	24
Selection of the DELAY START option.....	24
Starting the programme.....	25
At the end of the programme.....	25
<b>Programme charts: wash and special programmes</b> .....	26-27
<b>Cleaning and maintenance</b> .....	28
After each wash .....	28
Maintenance wash .....	28
Periodical cleaning .....	28
Exterior .....	28
Detergent dispenser drawer .....	28-29
Door seal.....	29
Drain filter .....	29
Water inlet filter .....	29-30
Emergency emptying out.....	30
Frost precautions.....	30
<b>Something not working?</b> .....	31
Troubleshooting.....	31-34
Unsatisfactory washing results .....	35
<b>Technical data</b> .....	36
<b>Service and Spare Parts</b> .....	37-38
<b>Standard Guarantee Conditions</b> .....	39
<b>European Guarantee</b> .....	40

<b>Instructions for installation and electrical connection</b> .....	41
Safety instructions for the installer .....	41
<b>Dimensions of the appliance</b> .....	42
Front view and side view .....	42
Rear view .....	42
<b>Installation</b> .....	43
Unpacking .....	43-44
Positioning .....	44
Levelling .....	44
Water inlet .....	45
Water drainage .....	45-46
Electrical connections .....	47
Permanent connection .....	48
<b>Building-in</b> .....	49-51
Preparation and assembly of the door .....	49-50
Recommendations .....	50-51



## Safety instructions

Your safety is of paramount importance, please ensure you read this instruction book before installing or using this appliance.

### General safety

- Repairs to the machine must be carried out only by qualified personnel. Repairs carried out by inexperienced persons could cause injury or serious malfunctioning. Contact your local AEG Service Force Centre.
- Never start the machine if the mains cable is damaged or the control panel is damaged allowing inner components to be accessible.
- Unplug the appliance before carrying out any cleaning or maintenance operations.
- Never pull the mains cable to remove the plug from the socket; always take hold of the plug itself.
- During high temperature wash programmes, the door glass may get hot.
- Let the water cool down before carrying out emergency emptying or before opening the door in an emergency.

### Installation

- Follow the installation instructions **carefully**.
- Carry out a first wash without laundry (COTTON 60, with half the amount of detergent) in order to remove any manufacturing residue from the tub and the drum.

## Child safety

- This appliance is designed to be operated by adults. Children should not be allowed to tamper with the controls or play with the appliance.
- Pets and children have been known to climb into washing machines. Please check the drum before use.
- Keep all packaging well away from children.
- Keep all detergents in a safe place out of children's reach.
- When disposing of the appliance, cut off the mains cable, and destroy the plug. Disable the door catch to prevent young children being trapped inside.

## During use

- Always unplug the appliance and turn off the water tap after use.
- This appliance is designed for domestic use only. If the machine is used for any other purposes or is not used correctly, the manufacturer accepts no responsibility for any possible damage that might occur.
- For safety reasons, the appliance must not be modified.
- Use only detergents suitable for washing machines and follow the manufacturer's instructions.
- Garments which have been in contact with flammable solvents should not be machine washed.
- Dyes and bleaching agents may only be used if specifically permitted by the manufacturer of these products. We cannot be held liable for any damage.



## Disposal

### Packaging materials

The materials marked with the symbol  are recyclable.

>PE<=polyethylene

>PS<=polystyrene

>PP<=polypropylene

This means that they can be recycled by disposing of them properly in appropriate collection containers.

### Machine

Use authorised disposal sites for your old appliance. Help to keep your country tidy!



## Tips for environmental protection

To save water, energy and to help protect the environment, we recommend that you follow these tips:

- Normally soiled laundry may be washed without prewashing in order to save detergent, water and time (the environment is protected too!).
- Use the energy saving programme when washing normally soiled garments.
- The machine works more economically if it is fully loaded.
- When small loads are washed, use only half to two thirds of the recommended amount of detergent.
- With adequate pre-treatment, stains and limited soiling can be removed; the laundry can then be washed at a lower temperature.



## Main features of your washing machine

- Programme and temperature setting using the programme selector.
- **Stain programme** for effectively treating stained washing.
- **Energy saving programme** for normally soiled cotton items.
- **Speed for the final spin** can be reduced to 900, 700 or 500 rpm.
- **RINSE HOLD**: the laundry is left immersed in the final rinse water to prevent creasing.
- **Delay start**: programme start can be delayed by 1 to 24 hours (e.g. to times with a more economical power rate).
- **Programme progress display** showing the programme steps selected and the programme phase which is running.
- Because of its gentle washing action, the **special wool cycle** washes your garments with extreme care.
- **3-compartment drawer** for detergent and fabric softener.
- **Unbalance detection device**: to prevent vibration during spinning.

# Description of the appliance

## Front view

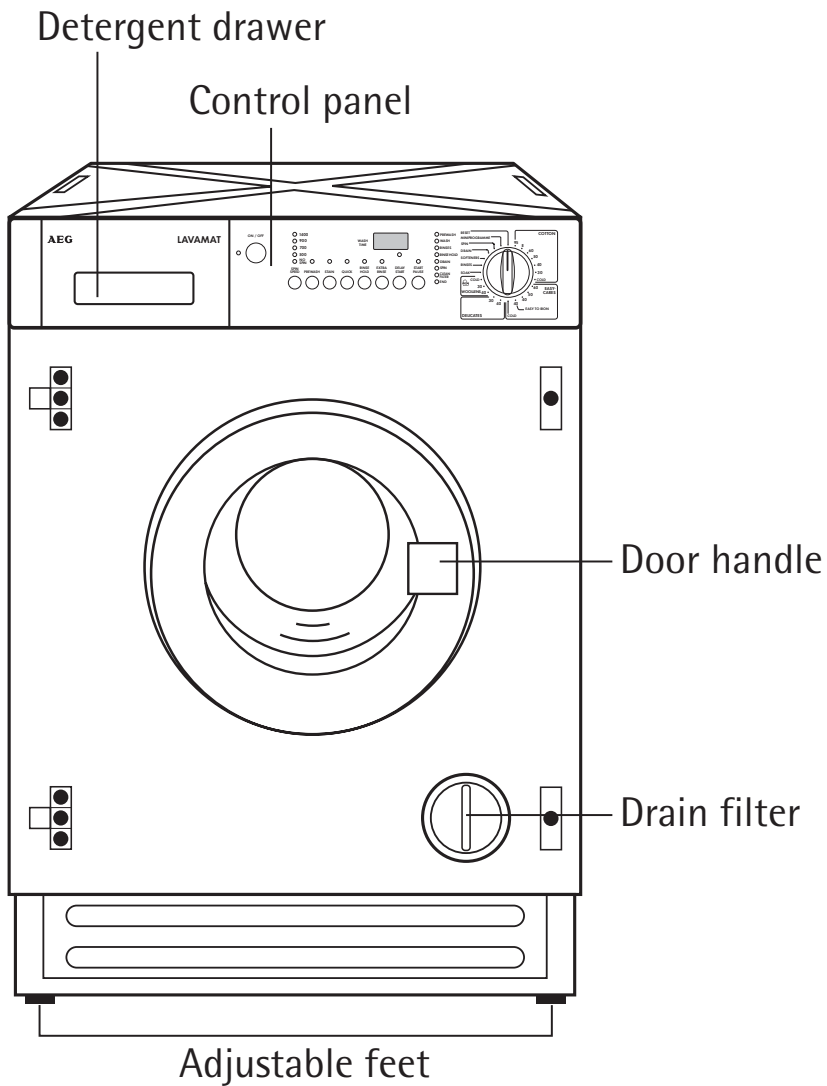

## Control panel

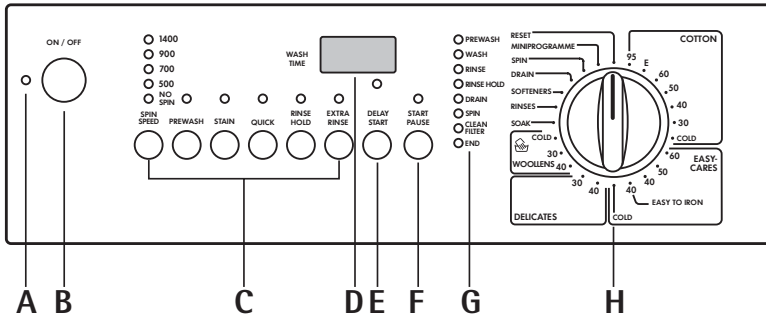

- A = Mains-on light
- B = ON/OFF button
- C = Option buttons
- D = Display
- E = Delay start button
- F = START/PAUSE button
- G = Programme progress display
- H = Programme selector dial

### Programme selector dial

The programme selector determines the type of washing cycle (e.g. water level, drum movement, number of rinses) and the washing temperature according to the type of laundry.

The selector dial is divided into 6 sections:

- Cotton
- Easy-cares
- Delicates
- Woollens  (hand washing)
- Special programmes
- Reset programme

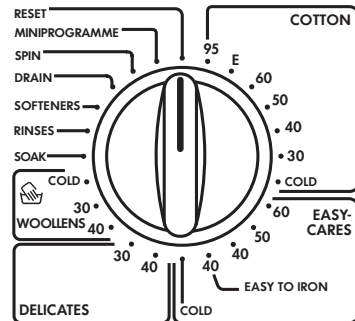

The selector dial can be turned either clockwise or anticlockwise.



Position **E** corresponds to the ENERGY SAVING programme at approx. 67°C for normally soiled laundry, extended washing time (cannot be combined with QUICK WASH).

**Position 40°C** Easy to iron.

In this position the laundry is gently washed and spun to avoid any creasing. In this way ironing is easier.

**Position COLD** = cold wash

## **ON/OFF button**

Press this button to switch the machine on. Press it again to switch the machine off.

## **Mains-on light**

This light comes on when the ON/OFF button is pressed, and goes out when it is pressed again.

## **START/PAUSE button**

This button has three functions:

### **a) Start**

After having selected the required programme, press this button to start the machine. If you have selected the DELAY START option, the machine starts its hourly countdown.

### **b) Pause**

To interrupt a programme which is running, press the START/PAUSE button: the corresponding pilot light starts to flash.

To restart the programme from the point at which it was interrupted, **press the START/PAUSE button again.**

### **c) Empty out water**

At the end of a programme which ends with water in the drum (RINSE HOLD option), or after the "soak" programme, press the START/PAUSE button to empty out the water: after the soak programme, the machine will empty only; after the programmes with RINSE HOLD option, the machine will empty and spin.

## **DELAY START button**

The wash programme can be delayed from 1 hour up to a maximum of 24 hours.

**The button must be pressed after selecting the programme and before pressing the START/PAUSE button.**

The figures indicating the delay appear for about 3 seconds in the display. The duration of the selected wash programme is then displayed. After depressing the START/PAUSE button, the machine starts its hourly countdown.

To alter or cancel the preset delay, press the START/PAUSE button, then press the DELAY START button until the required time is displayed or, if you wish to cancel the delay, until the symbol 0h is displayed.

Then press the START/PAUSE button again.

When the delay is cancelled, the display shows the duration of the wash programme previously selected.

## Programme Option buttons

Depending on the programme, different functions can be combined. These must be selected after choosing the desired programme and before depressing the START/PAUSE button.

When these buttons are pressed, the corresponding pilot lights come on. When they are pressed again, the pilot lights go out.

If an incorrect option is selected, the pilot lights flash for about 2 seconds and the message **Err** is displayed.

## SPIN SPEED

Press this button to reduce the maximum speed of the final speed proposed by the machine for the selected programme.

The maximum spin speed for cotton is 1400 rpm, for easy-cares and woollens 900 rpm and for delicates 700 rpm.

## NO SPIN

When selecting this option, all the spinning phases are cancelled. To be used for very delicate items.

This function **cannot** be used for cottons.

## PREWASH

The machine performs a prewash cycle at 30°C max. The prewash cycle ends with a short spin in programmes for Cotton and Easy-cares, and with emptying of the water without spinning for Delicates.

This option is not available with the wool programme and cannot be used with STAIN.

For use when washing heavily soiled laundry.

## STAIN

To treat heavily soiled or stained laundry with stain remover (extended main wash with time optimised stain action phase, **not** selectable for wool or programmes with temperatures lower than 40°C).

This function **cannot** be used with QUICK WASH and PREWASH.

## QUICK WASH

By pressing this button the washing time is reduced. For use when washing lightly soiled laundry.

This option is **not** available with the wool and economy programme and **cannot** be used with STAIN.

## RINSE HOLD

By selecting this option, the last rinse water is not emptied out, to prevent the fabrics from creasing. When the programme has finished, the corresponding pilot light on the programme progress display illuminates to indicate that the water must be emptied out. The light of START/PAUSE button flashes.

To empty out water:

- press the START/PAUSE button: after emptying, the machine performs the spin cycle required for the type of wash selected;
- select the spin speed and press START/PAUSE-button;
- select the DRAIN programme to empty out the water without spinning.

**Warning!** The programme selector dial must be turned first to RESET and then to the DRAIN programme.

**If the water is not emptied out, the machine automatically empties itself after 18 hours.**

## EXTRA RINSE

Can be used with all programmes **except the wool programme**. The machine performs 4 rinses instead of 3.

This option is recommended for people who are allergic to detergents and in areas where the water is very soft.

**Important!**

By depressing simultaneously START/PAUSE and EXTRA RINSE buttons the acoustic signal is suppressed in the following cases:

- by selecting the programme and the options;
- at the end of the programme;
- when an incorrect option selection is made.

## Display

The display shows the following information:

- If the programme selector dial is on the **RESET** position, **three flashing dashes** appear immediately after pressing the **ON/OFF** button to indicate that the machine is ready to be selected for the required wash programme.
- **Duration of the selected wash programme**, calculated automatically on the basis of the maximum recommended load for each type of fabric.
- When the programme has finished, **a flashing zero** is displayed.
- **Delayed start**, programmed using the special button.  
The selected delay is shown in the display and is updated every hour.
- **Incorrect option selection.** If an option which is not compatible with the set wash programme is selected, the message **Err** is displayed.
- **Alarm code** indicating a fault in the machine operation (see pages 31...34).

## Programme progress display

By selecting the wash programme, the pilot lights corresponding to the various phases making up the programme come on.

After the machine has started, only the running phase pilot light stays on. When the programme has finished, the **END** pilot light comes on.

If the **CLEAN FILTER** light flashes at the end of the programme this means that the drain filter is clogged.

The **END** pilot light flashes in the event of operating problems. At the same time one of the following lights starts to flash:

**RINSE HOLD** = the machine does not fill

**RINSE** = the machine does not empty

**WASH** = the door has not been closed

To eliminate the problem, see the "Something not working" section.



## **Cancelling/Altering a programme**

To cancel or alter a programme which is running, turn the programme selector dial to the RESET position: three flashing dashes will be displayed, the programme is cancelled. The machine will maintain the water in the tub. To drain water, select DRAIN programme. If you wish to select another programme maintaining the water in the tub, after cancelling the previously selected programme select a new one and then start it by pressing START/PAUSE button.

## **Opening the door after the programme has started**

You can open the door, after having set the machine to PAUSE, provided the following conditions exist:

- the machine is not in the heating phase beyond 55°C;
- the level of the water is not high;
- the drum is not turning.

If these requirements are met, when you pause the machine the door can be opened.

Should it not be possible to open the door, and should it be absolutely necessary to do so, switch the machine off by pressing the ON/OFF button.

After approximately 3 minutes, you can open the door.

**Pay attention to the level and temperature of the water in the machine!**

When you close the door and press the ON/OFF button again, the machine will resume the programme from the point where it had been interrupted.



## Detergent dispenser drawer

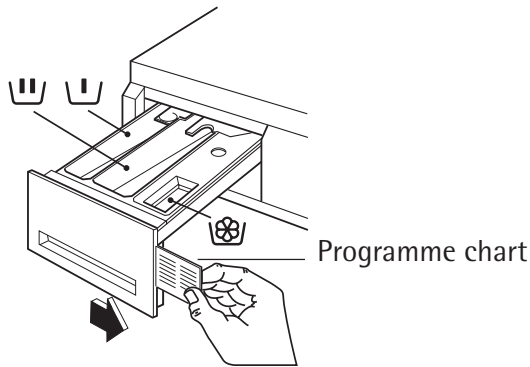

- Compartment for prewash or soak detergent and stain remover. The prewash or soak detergent is added at the beginning of the wash programme. The stain remover is added during the STAIN-Action phase in the main wash.
- Compartment for powder or liquid detergent used for main wash. It is emptied at the beginning of the wash cycle.
- Compartment for liquid additives (fabric softener, starch). It is emptied during the last rinse.

**The quantity of additives must not exceed the "MAX" mark in the drawer.**

## Before the first wash

Before your first wash, we recommend that you run a cotton cycle at 60°C, **without any laundry in the machine**, to remove any manufacturing residue from the drum and tub.

Pour 1/2 a measure of detergent into the dispenser drawer and start the machine.

# Preparing the wash cycle

## Sorting out and preparing the laundry

- Sort out the laundry according to type of fabrics and care labels (see "Types of fabric and care labels").
- Empty pockets.
- Remove any metal parts (safety pins, clips, etc.).
- To prevent the laundry from getting damaged and forming bundles, it is advisable to close zips, button up pillowcases and quilt covers and tie up loose straps such as those of aprons.
- Turn double faced items inside out (sleeping bags, anoraks, etc.)
- Turn coloured knitted fabrics, woollens and fabrics with trim inside out.
- Wash small and delicate items (baby socks, tights) inside a laundry net or in a pillow case closed with a zip, or in larger socks.
- Treat curtains with special care. Remove all metal or plastic hooks or put them in a net or a bag. We decline any responsibility in case of damage.
- Whites and coloureds must be washed separately: white items can lose their whiteness.
- New coloured fabrics often have excess dyes; it is advisable to wash them separately for the first time.
- Wash small and large items together; this improves the washing result and the laundry is better distributed during spinning.
- Shake out garments before putting them into the machine.
- Insert each garment separately.

## Weight of laundry

Sort of laundry	Approximate dry weights
Bathrobes	1200 g
Work shirts	300-600 g
Quilt covers	700 g
Sheets	500 g
Blouses	100 g
Hand towels	200 g
Tea towels	100 g
Shirts	200 g
Pillowcases	200 g
Night-gowns/Pyjamas	200-250 g
Tablecloths	200-300 g
Underwear	250 g

## Types of fabric and care labels

The labels on garments help you to select the most suitable wash programme. The laundry should be sorted out according to the type of fabric and the instructions indicated on care labels.

Temperatures indicated on labels are always maximum temperatures.

**Cotton** 



Linen and cottons marked with this symbol can be washed at high temperatures.

**Cotton** 

Linen and cottons marked with this symbol are colourfast and can be washed at 60°C.

**Cotton**  

Garments marked with these symbols have delicate colours, therefore the washing temperature must not exceed these values.

**Synthetics (Easy-cares)**  

Mixed and synthetic fabrics marked with these symbols require a gentle wash programme and they must therefore be washed using the specific programme.

**Delicates**  

Microfibres, synthetics or curtains marked with these symbols require a very gentle treatment.

The DELICATES programme is suitable for this type of fabric.

**Woollens and particularly delicate items**    

Fabrics such as wool, wool mix or silk marked with this symbol are particularly sensitive to machine washing.

The WOOLLENS programme is suitable for this type of fabric.

If the label has the symbol  (do not wash), the garments must not be machine washed!

# Detergents and additives

## Which detergent?....

To ensure you obtain the best wash results from your appliance, it is important to use the right detergent in your everyday wash, and only detergents recommended for use in automatic machines.

To maintain the appearance of your clothes and household textiles and to make them last longer you should use different types of detergent for different washes, whether for whites, colours or delicates.

### WHITES

We recommend the Ariel product range which is biological and designed to provide excellent cleaning and stain removal even at low temperatures.



### NON BIOLOGICAL

If you prefer to use a non biological detergent, which does not contain enzymes we recommend Fairy. Fairy provides good cleaning and stain removal.



### COLOURED

For coloured items you should use a detergent which is designed to clean while maintaining the original colour. Ariel Color does not contain bleach and therefore helps to preserve colours.



### DELICATE ITEMS

When washing delicates such as woollens, you should use a product which is specially designed to care for fine fabrics. Dreft Automatic is suitable for woollens and other delicates.



### LAUNDRY BLEACH

For additional stain removal you may wish to use a product such as Ace Gentle Bleach which is used in addition to your chosen detergent. Ace is suitable for all washable fabrics including silks, woollens and coloureds.



### STAIN REMOVER

For heavily soiled garments to be washed with STAIN-Action, you should use stain removers such as VANISH In-Wash, Ecover Stain Salt and GloWhite Booster.



## And in which form?

Not only are there different types of detergent, but they are also available in different forms. Whether you chose a powder or liquid in traditional or compact form is your own personal choice.

### TRADITIONAL POWDERS

Pour the powder directly into the dispenser drawer. Do not sprinkle powder onto clothes in the machine drum.

### TRADITIONAL LIQUIDS

Liquid can be placed in the main wash compartment of the detergent drawer marked with the symbol , start the machine immediately upon placing the detergent in the dispenser drawer.

Alternatively the detergent is measured into the specially designed dosing device\* which should be placed on top of the laundry, and at the back of the machine drum.

### COMPACT POWDERS AND LIQUIDS

Compact detergents (or concentrates as they are also known) are available in liquid or powder form, and generally require a smaller dosage. Follow the manufacturer's instructions to ensure the most economical usage. Pour the detergent directly into the dispenser drawer, or alternatively measure the detergent into the specially designed dosing device\* which should be placed on top of the laundry, and at the back of the machine drum.

\* **If you use a dosing device in a washer dryer, please ensure the dosing device/ball is removed before carrying out a drying programme.**

### FABRIC CONDITIONERS

These are ideal for improving "softness", and also reduce static cling on easy-cares and make ironing easier. They are available in two types:

- For example Lenor liquid fabric softener, for use in the **washing machine/washer dryer**. The liquid fabric softener should be poured into the compartment marked with the symbol . Follow the manufacturer's dosage instructions and never exceed the MAX level.



- Bounce conditioning sheets for use in a **tumble dryer**. We recommend the conditioning sheets are pinned (using a safety pin) to an article of laundry and placed in the tumble dryer.





## How to wash



### Max. load

- cottons 4.5 kg
- easy cares and delicates 2 kg
- wool 1 kg

### Load the laundry

-  Open the door.
-  Place the laundry in the drum, one item at a time. Distribute laundry as evenly as possible. Close the door.



### Add detergent and additive

-  Pull the drawer out till it stops.
-  Pour the main wash detergent into compartment .

If you wish to perform a pre-wash, a SOAK or a STAIN-Action programme, pour detergent or stain remover into compartment .

#### Important!

**Do not use normal detergent for the STAIN-Action programme, always use a STAIN remover.**

-  Pour the fabric softener into compartment  without exceeding the "MAX" mark.
-  Close the drawer gently, pushing it fully in.

### Switching the machine on

-  To switch the machine on, press the ON/OFF button: if the programme selector dial is on the RESET position, three flashing dashes will be displayed. If the programme selector dial is positioned on a wash programme, the duration of that programme will be displayed.

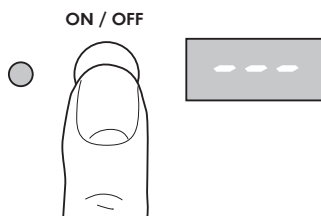

## Selection of the desired wash programme

 Turn the programme selector dial to the desired position: the lights corresponding to the different phases making up the selected programme light up. The display shows the duration of the programme.

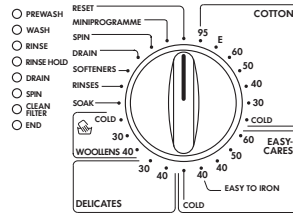

## Selection of the SPIN SPEED or NO SPIN option

 To select the desired spin speed, press the SPIN SPEED button: the corresponding light comes on. When selecting the NO SPIN option all the spinning phases are suppressed.



## Selection of the STAIN, PREWASH or QUICK WASH option,

depending on the degree of soil of the laundry and on the type of fabric.

The corresponding light comes on.

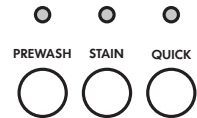

## Selection of the RINSE HOLD and/or EXTRA RINSE option

The corresponding light(s) come(s) on.

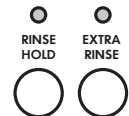

## Selection of the DELAY START option

 To delay starting of a programme, press the DELAY START button **before starting the machine**. The figures corresponding to the selected delay will be displayed for about 3 seconds, after which the duration of the selected programme will appear on the display. When the START/PAUSE button is pressed, the selected delay will again appear on the display and the machine starts its countdown.





## Starting the programme

- ☞ To start the selected programme, press the START/PAUSE button; the corresponding light stops flashing.

The pilot light corresponding to the wash phase which is running is illuminated.



**If the delay start option has been selected, the machine starts its countdown, in hours, which will appear on the display. During this period it is possible to load other laundry: press the START/ PAUSE button. Open the door. Load the laundry. Close the door and press the START/ PAUSE button again.**

## At the end of the programme

The machine stops automatically and a flashing zero is displayed.

The END pilot light stays on.

- ☞ If the RINSE HOLD option has been selected, the corresponding pilot light on the programme progress display remains lit to indicate that the water must be emptied out before opening the door.

The pilot light of the START/PAUSE button flashes and a zero is displayed.

At the end of the programme (after draining), a flashing zero is displayed.

- ☞ Turn the programme selector dial to RESET.
- ☞ Switch the machine off by pressing the ON/OFF button.
- ☞ Remove the laundry from the drum.  
Check that the drum is empty so as to avoid a subsequent wash being damaged by any forgotten items.
- ☞ Close the water tap.
- ☞ Leave the door open to prevent the formation of mildew and unpleasant smells.

# Programme chart

## Wash programmes

Wash programme	Temp.	Fabrics	Additional functions	Max. load	Consumption*		
					Energy kWh	Water lt.	Duration min.
White Cotton	95°-60°	Cotton and linen, for example normally soiled work garments, sheets, household linen, underwear, towels.	STAIN QUICK PREWASH EXTRA RINSE RINSE HOLD SPIN SPEED	4.5 kg	1.7	43	156
<b>E</b> Whites ECONOMY	67°	Cotton and linen, for example normally to lightly soiled sheets and household linen.	STAIN PREWASH EXTRA RINSE RINSE HOLD SPIN SPEED	4.5 kg	1.15	40	145
Coloured cottons	60°-50° 40°-30° COLD	Coloured cotton or linen fabric, shirts, underwear, towels.	STAIN QUICK PREWASH EXTRA RINSE RINSE HOLD SPIN SPEED	4.5 kg	0.85	40	137
Easy-cares	60°-50° 40° COLD	Synthetic fabrics, underwear, coloured garments, non-shrink shirts, blouses.	STAIN QUICK PREWASH EXTRA RINSE RINSE HOLD SPIN SPEED NO SPIN	2 kg	0.75	57	97
Delicates	40°-30°	Delicate fabrics, for example curtains.	STAIN QUICK PREWASH EXTRA RINSE RINSE HOLD SPIN SPEED NO SPIN	2 kg	0.5	55	67
Woolens hand wash 	40°-30° COLD	Wool, wool mixture, silk and fabrics to be handwashed.	RINSE HOLD SPIN SPEED NO SPIN	1 kg	0.4	50	57

In compliance with EC directive 92/75, the consumption figures indicated on the energy label refer to the 60°C wash programme for cotton.

\* The consumption data shown on this chart is to be used as a guide only, as it may vary depending on the quantity and type of laundry, on the inlet water temperature and on the ambient temperature. It refers to the highest temperature for each wash programme.

# Programme chart

## Special programmes

Pro-gramme	Type of laundry	Programme phases	Additional functions	Max. load	Consumption*		
					Energy kWh	Water lt.	Duration min.
Soak	Heavily soiled fabrics, except wool.	Soak at 30°C. Stop with water in drum. <b>To empty:</b> press the START/PAUSE button. The machine automatically empties itself after 18 hours.		4.5 kg	0.25	19	20
Rinses	This programme can be used for rinsing hand washed garments.	3 rinses with liquid additive. Spin.	EXTRA RINSE RINSE HOLD SPIN SPEED	4.5 kg	0.12	30	48
Softeners	Hand washed garments to be starched or softened.	1 rinse with liquid additive. Spin.	RINSE HOLD SPIN SPEED	4.5 kg	/	15	21
Drain	For emptying out the last rinse water in programmes with the Rinse Hold option.	The water is emptied out.		/	/	/	3
Spin	Separate spin for all fabrics.	Spin.		4.5 kg	/	/	10
Miniprogramme	Lightly soiled fabrics except wool	Wash at 30°C 2 rinses Short spin. (700 rpm max)	RINSE HOLD SPIN SPEED	2 kg	0.25	40	30
Reset	Cancel.	For cancelling the wash programme which is running.					

\* The consumption data shown on this chart is to be used as a guide only, as it may vary depending on the quantity and type of laundry, on the inlet water temperature and on the ambient temperature.

# Cleaning and maintenance

## After each wash

- ☞ At the end of the wash programme, pull the dispenser drawer out a little to let it dry.
- ☞ Leave the door ajar to allow air to circulate.

## If the machine is not used for a prolonged period:

- ☞ Close the water tap and unplug the appliance.

## Maintenance Wash

With the use of low temperature washes it is possible to get a build up of residues inside the drum.

We recommend that a maintenance wash be performed on a regular basis.

### To run a maintenance wash:

- ☞ The drum should be empty of laundry.
- ☞ Select the hottest cotton wash programme.
- ☞ Use a normal measure of detergent, must be a powder (such as Ariel Futur).

## Periodical cleaning

### Exterior

- ☞ Clean the outside of the cabinet with soap and water only. Rinse with clean water and dry.

**Important:** do not use methylated spirits, solvents or similar products to clean the cabinet.

### Detergent dispenser drawer

After a while, detergents and fabric softeners leave deposits in the drawer.

- ☞ Clean the drawer, from time to time, by rinsing it under a running tap. To remove the drawer from the machine, press the button in the rear left-hand corner.

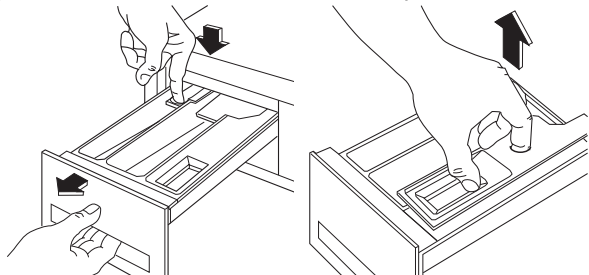

- ☞ To facilitate cleaning, the top part of the additive compartment can be removed.
- ☞ Detergent can also accumulate inside the drawer recess: clean it with an old toothbrush.
- ☞ Refit the drawer after cleaning.

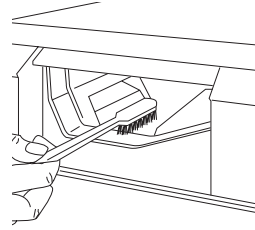

## Door seal

Regularly check to see, if there are deposits or foreign objects in the rubber seal behind the door and remove them.

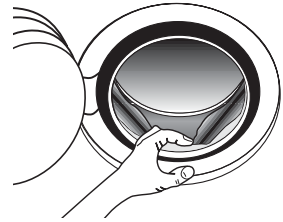

## Drain filter

The drain filter collects threads and small objects inadvertently left in the laundry. Check regularly that the filter is clean.

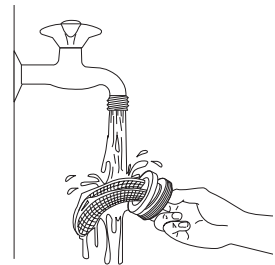
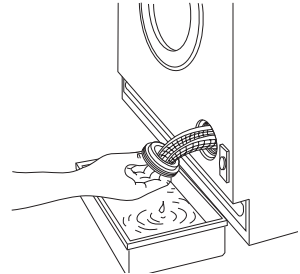
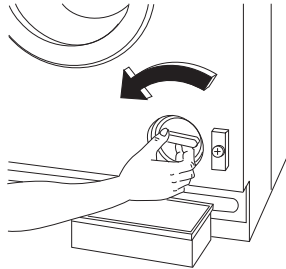

- ☞ Place a container under the filter and unscrew it; some water will come out of the filter.
- ☞ Pull out the filter.
- ☞ Clean the filter under a running tap, then refit it, screwing it fully in.



## Water inlet filter

If you notice that the machine is taking longer to fill, check that the filter in the water inlet hose is not blocked.

- ☞ Turn off the water tap.

-  Unscrew the hose from the tap. To do this you must press the yellow button on the hose first.
-  Clean the filter with a stiff brush.
-  Screw the hose back onto the tap.

## Emergency emptying out

If the water is not discharged (pump is blocked, filter or drain pipe are clogged), proceed as follows to empty out the machine:

- pull out the plug from the power socket;
- close the water tap;
- if necessary, wait until the water has cooled;
- place a bowl on the floor;
- put the drain hose end into the bowl and let the water out.

Should it not be possible to have access to the drain hose because, for example the appliance is built in the kitchen furniture, slightly loosen the drain filter after placing a bowl on the floor to let the water come out slowly.

At the end screw the filter again.

## Frost precautions

If the machine is installed in a place where the temperature could drop below 0°C, proceed as follows:

- Close the water tap and unscrew the water inlet hose from the tap.
- Place the end of the drain hose and the inlet hose in a bowl placed on the floor.
- Select the "DRAIN" programme and run it until the machine stops.
- Turn the programme selector dial to RESET.
- Remove the plug from the power socket.
- Screw the water inlet hose back on and put the drain hose back in its place.

By doing this, any water remaining in the machine is removed, avoiding ice forming and consequently damage to the appliance.

When you use the machine again, make sure that the ambient temperature is above 0°C.

## Something not working?

- i** If during the spin cycle the machine makes an unusual whistling noise, different from the noise made by traditional washing machines, this is due to a new type of motor.



If water is not visible in the drum, this is due to the modern technology of new washing machines that use less water than traditional machines.

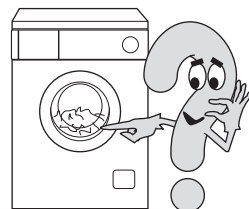

## Troubleshooting

If a problem arises, you can try to solve it yourself following the instructions below.

**If you call out an engineer when one of the following problems arises, or to repair a fault due to incorrect use, the call-out will be charged even if requested within the guarantee period.**

During machine operation the following alarm codes may be displayed:

- **E10:** problem with the water supply (phase light RINSE HOLD is on)
- **E20:** problem with water draining (phase light RINSES is on)
- **E40:** door open (phase light WASH is on)

Once the problem has been eliminated, press the START/PAUSE button to restart the programme. If after all checks, the problem persists, contact your local AEG Service Force Centre.

Problem	Possible cause	Solution
The machine does not work	The ON/OFF button has not been depressed.	Depress the button.
	The main electrical fuse has blown.	Replace the fuse.
	The door is not properly closed ( <b>E40</b> ).	Close the door; the click of the lock should be heard.
	The plug is not connected or the fuse in the plug has blown.	Insert the plug or replace the fuse.
	The START/PAUSE button has not been pressed.	Press the button.
	The DELAY START option has been selected.	Check the selected delay on the display.

Problem	Possible cause	Solution
The machine does not fill	The water tap is closed <b>(E10)</b> .	Open the water tap.
	The water inlet hose is squashed or kinked <b>(E10)</b> .	Check the whole length of the hose and remove the kink.
	The small filter of the water inlet hose is clogged <b>(E10)</b> .	Clean the filter.
	The door is not properly closed <b>(E40)</b> .	Close the door.
The machine fills then empties immediately	The end of the drain hose is too low.	Place the hose at the right height (see Installation section).
The machine does not empty and/or does not spin	The drain hose is squashed or kinked <b>(E20)</b> .	Check the whole length of the hose and remove the kink.
	The drain filter or the drain hose are clogged <b>(E20)</b> .	Clean the filter or check the hose.
	The RINSE HOLD option (stop with water in drum) has been selected.	Empty out the water by pressing the START/PAUSE button or selecting the DRAIN programme.
	The NO SPIN option has been selected	Check if your laundry has to be spun
	The laundry is not evenly distributed inside the drum.	Redistribute the laundry manually in the drum.
There is water on the floor	Too much detergent has been used.	Measure detergent according to the manufacturer's instructions.
	An unsuitable detergent has been used that creates too much foam.	Use a suitable washing machine detergent.
	One of the connectors on the water inlet hose is leaking.	Check that the hose is firmly screwed on at both ends.
	The drain filter has not been properly screwed on after cleaning.	Fully screw the filter into place.



Problem	Possible cause	Solution
The machine vibrates or is noisy	The transit bolts have not been removed.	Check that the machine has been unpacked as described in the Installation section.
	The feet have not been adjusted.	Carefully level the machine.
	There is little laundry in the drum.	Correct operation of the machine is not affected.
The door will not open	The programme is still running and the drum is turning.	Wait until the end of the programme before opening the door.
	The water level is above the bottom edge of the door.	Before opening the door, the water must be emptied out.
	The machine is heating the water.	Wait until the end of the heating phase.

<b>Problem</b>	<b>Possible cause</b>	<b>Solution</b>
Spinning starts late or the machine does not spin	The unbalance detection device that prevents excessive vibration during spinning has cut in.	<p>If the laundry is not evenly distributed inside the drum at the beginning of the spin cycle, the machine detects this and tries to redistribute it more evenly by means of a few drum rotations.</p> <p>Only when the laundry is more evenly distributed will the spin cycle be performed, at a lower speed, if the laundry is not evenly distributed.</p> <p>If, after about 6 minutes, the laundry is still tangled, the machine will not spin. Therefore, if the laundry is still wet at the end of the cycle, it is advisable to redistribute it manually inside the drum and to select the spin programme.</p>

## Unsatisfactory washing results

### **If the laundry looks grey and lime scale is found in the drum**

- Too little detergent has been used.
- An unsuitable detergent has been used.
- Stubborn stains have not been treated prior to washing.
- The programme/temperature has not been correctly selected.

### **If grey stains remain on the laundry**

- Laundry stained with ointments, grease or oil has been washed with an insufficient amount of detergent.
- The temperature selected for the wash programme was too low.
- Fabric softener - especially the concentrated type - has come into direct contact with the laundry. Wash these stains immediately and pour fabric softener carefully.

### **Foam is still visible even after the last rinse**

- Modern detergents often produce foam, even in the last rinse. However the laundry has been completely rinsed.

### **White residue is left on the laundry**

- This is due to insoluble components in modern detergents and is therefore not the result of insufficient rinsing. Shake or brush the laundry. In future, it may be better to turn garments inside out before washing them. Check the choice of detergent; try using liquid detergents.

## Technical data

Height x Width x Depth	82x60x54.5 cm
Depth with door opened	91 cm
Height adjustment	± 13 mm approx.
Net weight	75 kg approx.
Load (depending on programme)	4.5 kg max.
Use	domestic
Drum speed during washing	max. 55 rpm
Drum speed during spinning	1400/900/700/500 rpm
Water pressure	50–800 kPa



**This appliance complies with the following EC directives:**

- 73/23/EEC of 19.2.1973 "Low voltage directive", including directive 93 / 68 / EEC
- 89/336/EEC of 3.5.1989 "Electromagnetic Compatibility Directive".

## Service & Spare Parts

If after carrying out the necessary checks there is still a fault with your appliance please contact your local AEG Service Force Centre.

**In guarantee customers should ensure that the suggested checks in the "Troubleshooting" section have been made as the engineer will make a charge if the fault is not a mechanical or electrical breakdown.**

Please note that proof of purchase is required for in-guarantee service calls.

### Service & Spare Parts

If you require a service engineer or wish to purchase spare parts, contact your local AEG Service Force Centre, by telephoning:

**08705 929 929**

For the address of your local Service Force Centre and further information about Service Force, please visit the website at [www.serviceforce.co.uk](http://www.serviceforce.co.uk).

### Help us to help you

Please determine your type of enquiry before telephoning. When you contact us we need to know:

1. Your name, address and post code.
2. Your telephone number.
3. Clear and concise details of the fault.
  - What is the fault?
  - When does the fault occur?
  - Does the multi-display issue an error-message (*E* and a number)?
4. The model, production number and production identification number.
5. Date of purchase.

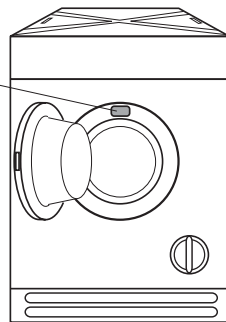
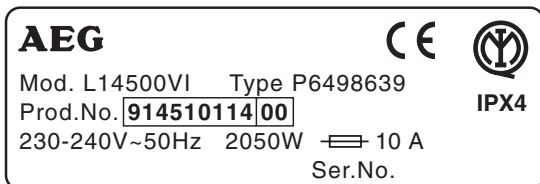

This information can be found on the rating plate, so you have these numbers to hand we recommend you write them below.

Prod. No. ....

Ser.-No. ....

**Customer care**

For general enquiries regarding your AEG appliance, or further information on AEG products please contact our Customer Care Department at the address below or visit our website at [www.aeg.co.uk](http://www.aeg.co.uk).

Customer Care Department  
AEG Domestic Appliances  
55-77 High Street  
Slough  
Berkshire SL1 1DZ  
Tel: 08705 350350\*

\* Calls to this number may be recorded for training purposes.

# Standard Guarantee Conditions

We, AEG, undertake that if within 12 months of the date of the purchase this AEG appliance or any part thereof is proved to be defective by reason only of faulty workmanship or materials, we will, at our discretion repair or replace the same FREE OF CHARGE for labour, materials or carriage on condition that:

- The appliance has been correctly installed and used only on the electricity or gas supply stated on the rating plate.
- The appliance has been used for normal domestic purposes only, and in accordance with the manufacturer's operating and maintenance instructions.
- The appliance has not been serviced, maintained, repaired, taken apart or tampered with by any person not authorised by us.
- All service work under this guarantee must be undertaken by a Service Force Centre. Any appliance or defective part replaced shall become the Company's property.
- This guarantee is in addition to your statutory and other legal rights.
- Home visits are made between **8.30am and 5.30pm** Monday to Friday. Visits may be available outside these hours in which case a **premium** will be charged.

## Exclusions

This guarantee does not cover:

- Damage or calls resulting from transportation, improper use or neglect, the replacement of any light bulbs or removable parts of glass or plastic.
- Costs incurred for calls to put right an appliance which is improperly installed or calls to appliances outside the United Kingdom.
- Appliances found to be in use within a commercial environment, plus those which are subject to rental agreements.
- Products of AEG manufacture which are not marketed by AEG.

## European Guarantee

If you should move to another country within Europe then your guarantee moves with you to your new home subject to the following qualifications:

- The guarantee starts from the date you first purchased your product.
- The guarantee is for the same period and to the same extent for labour and parts as exist in the new country of use for this brand or range of products.
- This guarantee relates to you and cannot be transferred to another user.
- Your new home is within the European Community (EC) or European Free Trade Area.
- The product is installed and used in accordance with our instructions and is only used domestically, i.e. a normal household.
- The product is installed taking into account regulations in your new country.

Before you move please contact your nearest Customer Care Centre, listed below, to give them details of your new home. They will then ensure that the local Service Organisation is aware of your move and able to look after you and your appliance.

France	Senlis	+33 (0) 3 44 62 29 29
Germany	Nürnberg	+49 (0) 800 234 7378
Italy	Pordenone	+39 (0) 800 11 75 11
Sweden	Stockholm	+46 (0) 8 672 53 60
UK	Slough	+44 (0) 1753 219899



# Instructions for installation and electrical connection



## Safety instructions for the installer

- This appliance is heavy, care should be taken when moving it.
- When unpacking the appliance, check that it is not damaged. If in doubt, do not use it and contact the retailer.
- All internal packing must be removed before using the appliance. Serious damage may be caused to the machine or adjacent furniture if the protective transit devices are not completely removed. Refer to the relevant paragraph.
- Any electrical work required to install this appliance must be carried out by a qualified electrician or competent person.
- Any plumbing work required to install this appliance must be carried out by a qualified plumber or competent person.
- After having installed the machine, check that it is not standing on its electrical supply cable.
- If the appliance is placed on a carpeted floor, ensure that air can circulate freely between the adjustable feet and the floor.
- The installation should comply with local water authority and building regulations requirements.
- Should the appliance power supply cable need to be replaced, this should be carried out by our Service Force Centre.

# Dimensions of the appliance

## Front view and side view

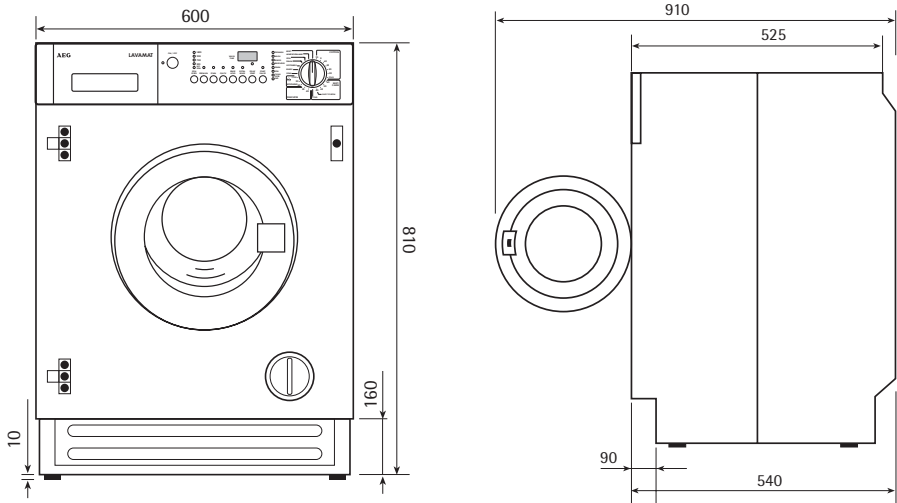

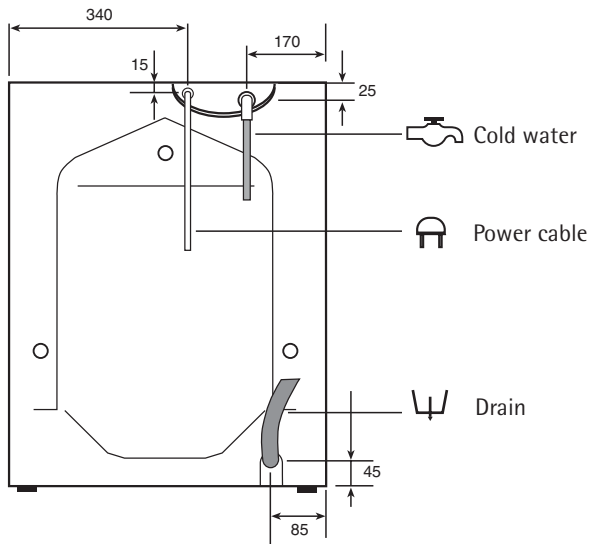

## Rear view





# Installation

## Unpacking

 All transit bolts and packing must be removed before using the appliance.

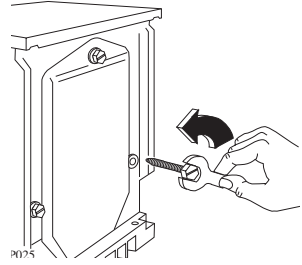
 Using a spanner, unscrew and remove the rear right-hand bolt and lay the machine on its back, taking care not to squash the hoses. This can be avoided by placing one of the corner packing pieces between the machine and the floor.



 Remove the polystyrene base and take off the bottom panel by unscrewing the central screw.

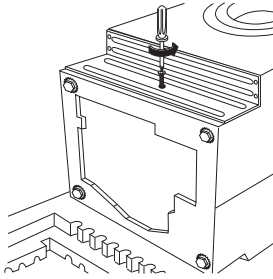

 Carefully slide out the right polythene bag.

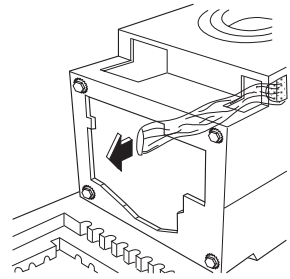

 Repeat the operation for the left and central polythene bags.

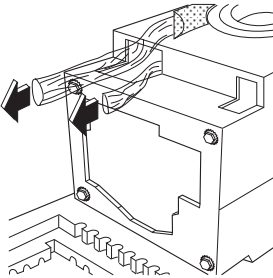

 Re-fit the bottom panel using the 4 screws supplied with the door hinges (in the plastic bag) and the previously removed screw.

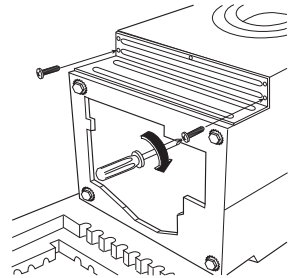

- ☞ Set the machine upright and remove the two remaining bolts from the back.
- ☞ Pull out the three plastic spacers from the holes into which the bolts were fitted.

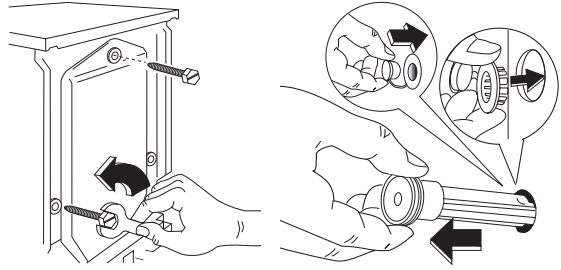

- ☞ Plug the open holes with the plugs which you will find in the envelope containing the instruction booklet.

You are advised to keep all transit devices so that they can be refitted if the machine ever has to be transported again.

## Positioning

Install the machine on a flat hard floor.

Make sure that air circulation around the machine is not impeded by carpets, rugs etc.

- Before placing it on small tiles, apply a rubber coating.
- Never try to correct any unevenness in the floor by putting pieces of wood, cardboard or similar materials under the machine.
- If it is impossible to avoid positioning the machine next to a gas cooker or coal-burning stove, an insulating panel (85x57 cm) covered with aluminium foil on the side facing the cooker or stove, must be inserted between the two appliances;
- The machine must not be installed in rooms where the temperature can drop below 0°C.
- The water inlet hose and the drain hose must not be kinked.
- Please ensure that when the appliance is installed, it is easily accessible for the engineer in the event of a breakdown.

## Levelling

Carefully level by screwing the adjustable feet in or out. Never place cardboard, wood or similar materials under the machine to compensate for any unevenness in the floor.

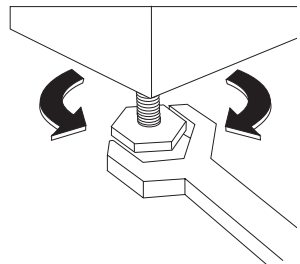

## Water inlet (cold water connection only)

Connect the hose to a tap with a 3/4" thread.

Installation should comply with local water authority and building regulations' requirements.

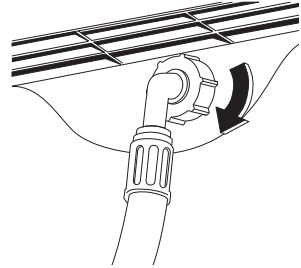
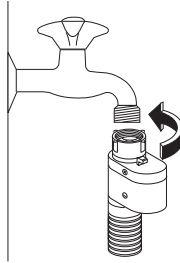

Set the hose correctly by loosening the ring nut. After positioning the inlet hose, be sure to tighten the ring nut again to prevent leaks.

### Do not connect to a hot water supply.

The inlet hose is provided with a water stop device, which protects against damage caused by water leaks in the hose which could develop due to natural ageing of the hose. This fault is shown by a red sector in the window "A". Should this occur, turn the water tap off and refer to your Service Force Centre to replace the hose.

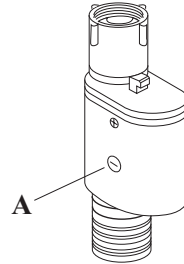

## Water drainage

The appliance drain hose should hook into a standpipe, the hook in the drain hose is formed using the plastic "U-Piece" supplied. The standpipe should have an internal diameter of approximately 38 mm (see diagram) thus ensuring there is an air break between the drain hose and standpipe.

When discharging into a standpipe ensure that the top of the curve in the hose end is no more than 90 cm (35.4") and no less than 60 cm (23.6") above floor level.

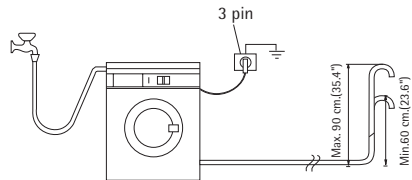

The upright standpipe should have a minimum length of 30 cm (12") from the bottom of the elbow to the top of the pipe (see diagram). Make sure that it is designed in such a way that the end of the drain hose cannot be covered with water.

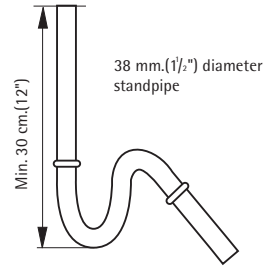

If you intend the drain hose from the machine to empty into a sink, make sure that the sink is empty and the plug hole is not blocked. Use the plastic "U -Piece" supplied.

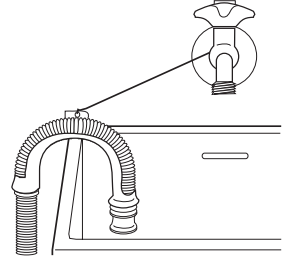

**Important**

Before connecting up the machine to new pipework or to pipework that has not been used for some time, run off a reasonable amount of water to flush out any debris that may have collected in the pipes.

**In the interest of the environment**

Washing machines and dishwashers should be connected to the FOUL drainage system, the water will then be taken to a sewage works for treatment before being discharged safely into a river.

It is essential that these appliances are not connected to the surface water drainage system as this water is discharged directly into a river or stream and may cause pollution.

If you require any further advice please contact your local water authority.

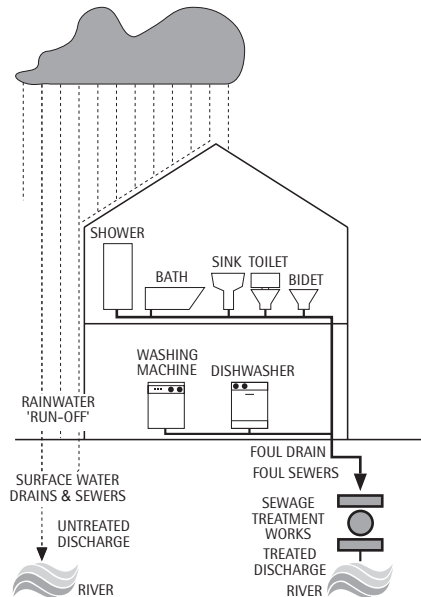

## Electrical connections



**WARNING: THIS APPLIANCE MUST BE EARTHED.**

The manufacturer declines any liability should this safety measure not be observed.

If the plug that is fitted to your appliance is not suitable for your socket outlet, it must be cut off and the appropriate plug fitted.

Remove the fuse from the cut off plug.

The cut off plug should then be disposed of to prevent the hazard of shocks in case it should be plugged into a 13 Amp socket in another part of your home.

### Important

The wires in the mains lead are coloured in accordance with the following code:

Green and Yellow	- Earth
Blue	- Neutral
Brown	- Live

If you fit your own plug, the colours of the wires in the mains lead of your appliance may not correspond with the markings identifying the terminals in your plug, proceed as follows:

Connect the green and yellow (earth) wire to the terminal in the plug which is marked with the letter «E» or the earth symbol  $\perp$  or coloured green and yellow.

Connect the blue (neutral) wire to the terminal in the plug which is marked with the letter «N» or coloured black.

Connect the brown (live) wire to the terminal in the plug which is marked with the letter «L» or coloured red.

The plug moulded on to the lead incorporates a fuse. For replacement, use a 13 Amp BS1363/A fuse. Only ASTA or BSI approved fuses should be used.

The plug must not be used if the fuse cover/carrier is lost. The cover/carrier is indicated by the coloured insert at the base of the plug. A replacement cover/carrier must be obtained from your local AEG Service Centre.

The power supply cable must be easily accessible after installing the machine.

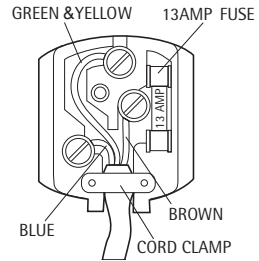

## **Permanent connection**

In the case of a permanent connection it is necessary that you install a double pole switch between the appliance and the electricity supply (mains), with a minimum gap of 3 mm between the switch contacts and of a type suitable for the required load in compliance with the current electrical regulations.

The switch must not break the yellow and green earth cable at any point.

This operation should only be performed by a qualified electrician.



# Building-in

This appliance has been designed to be built into the kitchen furniture. The recess should have the dimensions shown in picture A.

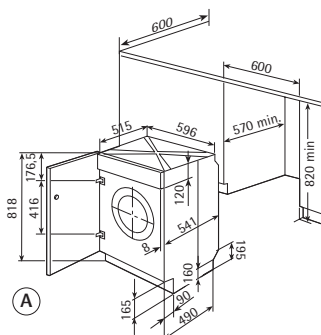

## Preparation and assembly of the door

The machine is originally pre-arranged for the assembly of a door opening from right to left. In this case it is sufficient to screw in the hinges (1) and the counter-magnet (6) provided with the appliance, at the right level (Fig. B).

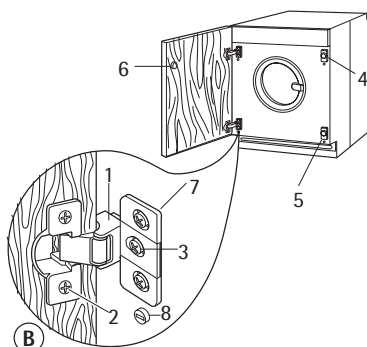

### a) Door

The dimensions of the door should be:

- width 595-598 mm
- thickness 16-22 mm

The height (C-Fig. C) depends on the height of the adjacent furniture's base.

### b) Hinges

To mount the hinges it is necessary to drill two holes (dia. 35 mm, depth 12.5-14 mm) on the inner side of the door. The distance between the holes hobs fixing centres must be 416 mm.

The distance (B) from upper edge of the door to the centre of the hole depends on the adjacent furniture's dimensions.

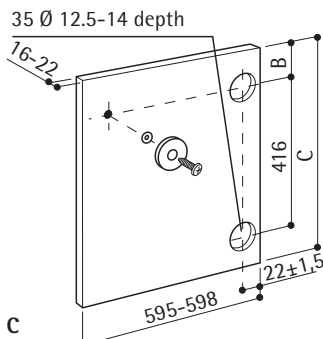

The required dimensions are given in the picture C.

The hinges will be fixed to the door by means of screws for wood (2-Fig. B) supplied with the appliance.

### c) Mounting the door

Fix the hinges (1) to the machine by means of the M5x8 screws (3-Fig. B). The hinges can be adjusted to compensate for possible uneven thickness of the door.

To align the door perfectly it is necessary to loosen the screw (3-Fig. B), adjust the door and tighten the screw again.

### d) Counter-magnet (6)

The appliance is pre-arranged for a magnetic closure of the door. To enable a correct operation of this device, it is necessary to screw the counter-magnet (6) (steel disk + rubber ring) into the inner side of the door.

Its position must correspond to the magnet (4) on the appliance (see picture D).

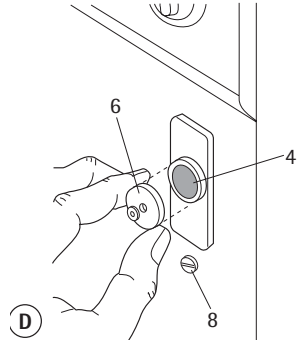

If the door has to be opened from left to right, invert the position of the plates (7), the magnet (4) and the plate (5) (Fig. B and E). Mount the counter magnet (6) and the hinges (1) as previously described.

**Important:** the plastic screw (8) should **never** be loosened (Fig. B and E).

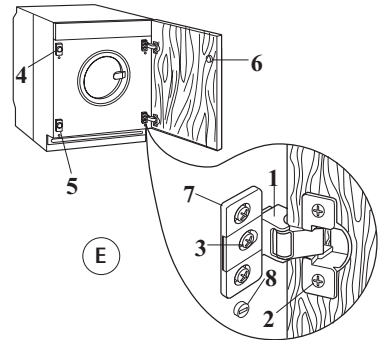

## Recommendations regarding the construction and fitting of a base when the installation requires an integrated appliance to be raised

Where the appliance has been raised by mounting onto a wooden base provided by the installer. The material used to construct the base should have a non slip surface, be water repellent and if possible be one solid piece.

If it is not possible to use one solid piece, due to the additional height required, ensure that any additional strips of timber are glued and screwed to the underside of the base (see Fig. F).

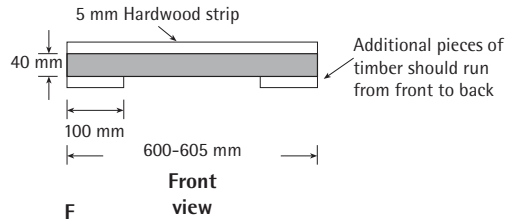

Drill four fixing holes see Fig. G

Position the base into the recess with its front edge as far forward as the adjoining plinth line will allow. **The reason for placing the base in this position is to allow a small strip of beading to be fitted in front of the appliance feet.**

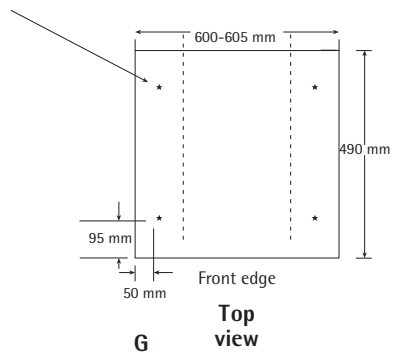

Fix the base firmly to the floor using four appropriate countersunk screws (see Fig. H).

With the appliance installed adjust all four feet ensuring the machine is stable, and a clearance of approximately 5 mm is left between the top of the machine and the underside of the work-top.

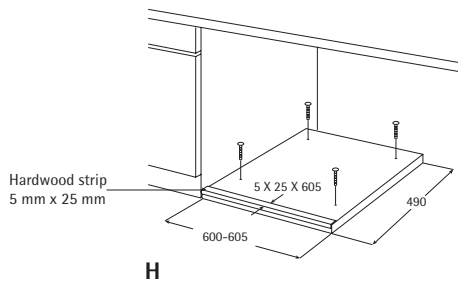

A final check for stability should be carried out with the machine on spin with a load, this will identify the need for any further fine adjustment to the feet.

A strip of beading approximately 605 mm W, x 5 mm H, x 25 mm D must be screwed down into the base directly in front of the machine's feet, this will provide additional security.

If required an additional door magnet, part number 1242394-00/3 and disc, part number 1242393-00/5 are available from spare parts.

AEG Hausgeräte GmbH  
Postfach 1036  
D-90327 Nürnberg

<http://www.aeg.hausgeraete.de>

132.992.080-01-0503 Subject to change without notice



**From the Electrolux Group. *The world's No. 1 choice.***

*The Electrolux Group is the world's largest producer of powered appliances for kitchen, cleaning and outdoor use. More than 55 million Electrolux Group products (such as refrigerators, cookers, washing machines, vacuum cleaners, chain saws and lawn mowers) are sold each year to a value of approx. USD 14 billion in more than 150 countries around the world.*

© Electrolux plc 2003